



DAVRAIL INCORPORATED

XO+ Specifications Features and Benefits

- **27,550lbs lifting capability per machine.**
- Ideal for removing and installing turnouts and panels on both **single line and multiple line systems.**
- Can **easily cross multiple tracks.**
- **Compact size and maneuverability** enables easy transportation, and rapid deployment to and from site.
- **Fully adjustable** lifting beam setup.
- Designed to handle any gauge or composition of track panel.
- Can safely perform work at **gradients of up to 11°.**
- Lift Plan provided.

Machine Data	Imperial	Metric
Gradient	1:5, 20%, 11° (Alarm Setting)	
Noise Levels (High Engine Speed)	76.dB(A) @1M Engine Idle, 84.dB(A) @3.28 ft Engine Full	

Engine Data	Imperial	Metric
Engine Type	Kubota O3 Series - V2403-CR-E5	
Cylinders	4 In-Line	
Power Output	32 kW, 43 bhp @ 2,100 rpm	
Emissions	EU Stage V, Tier 4 Final	
Alternator	2-volt 40 amp	
Battery	Type 017 - 12V, 90 Ah, 720A CCA.	
Oil Type	Shell Rimula RT4X 15w-40	
Oil Capacity	2.51 US gallons	9.5 litres
Coolant Capacity	2.25 US gallons	8.5 litres
Coolant	Valvoline Maxlife 50/50	
Fuel Type	Diesel	
Fuel Tank	26.4 US gallons	100 litres

Hydraulic Data	Imperial	Metric
System Pressure	160 Bar	
Leg Ram Pressure	140 Bar	
Oil Type	Shell Naturelle HFE 46 - Synthetic Biodegradable	
Tank Capacity	16 gallons (Min) 53 US gallons (Max)	60 litres (Min) 200 litres (Max)
Pump	43.98 cc ³ /rev - 23 gallons/ min @ 2,100 rpm	43.98 cc ³ /rev - 88 Litres/ min @ 2,100 RPM





DAVRAIL
INCORPORATED

www.davrail.com
A New Way Forward In Maintenance of Way

Dimensions

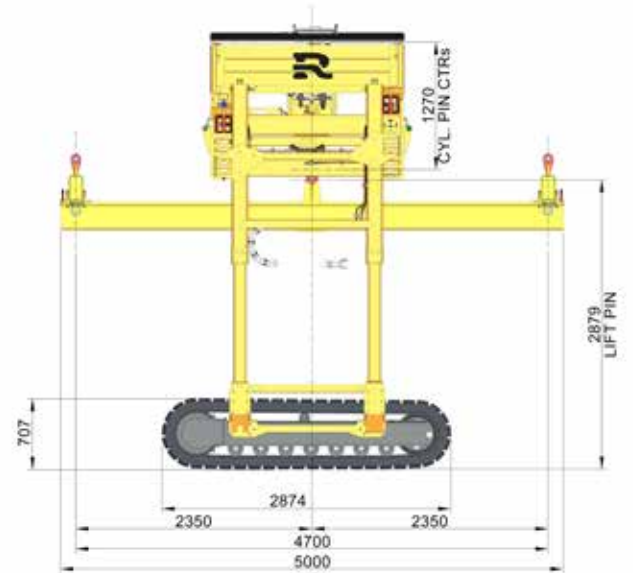
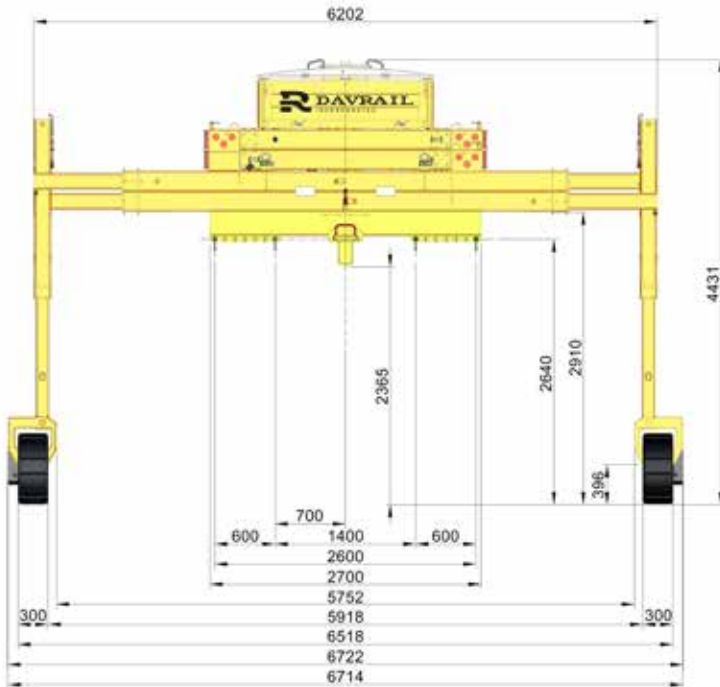

XO+ FULLY EXTENDED

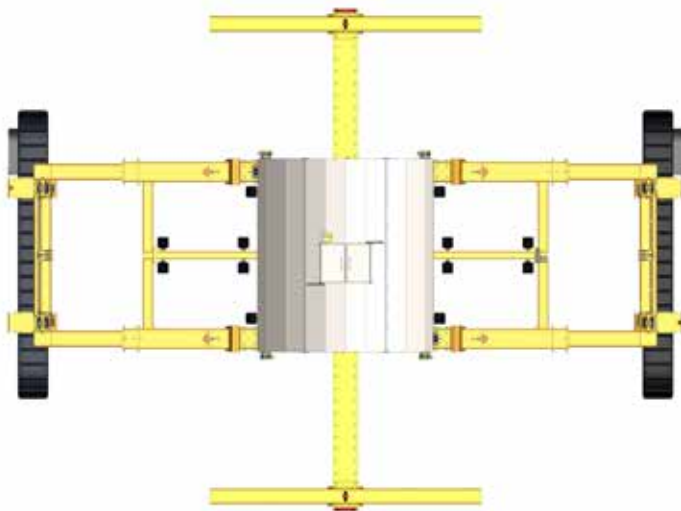

+1-717-DAV-RAIL
contact@davrail.net

DavRail Incorporated
6300 Ridglea Place, Suite 1208
Fort Worth, Texas 76116

*These products are being continuously improved and updated. As such, specifications and information are subject to change.